

This document contains information that is confidential and proprietary to CORIGY, that will not be copied or reprinted or delivered

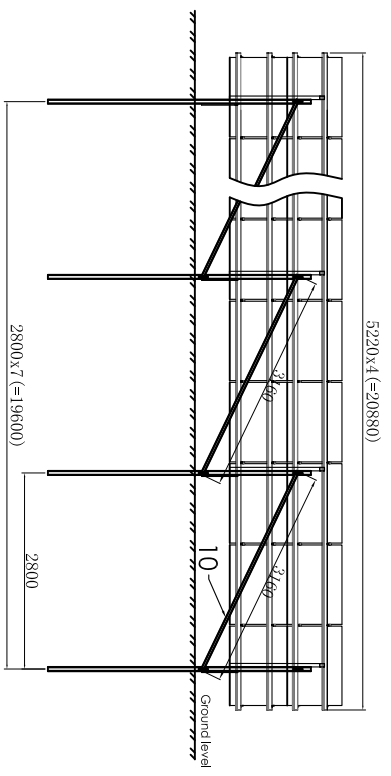
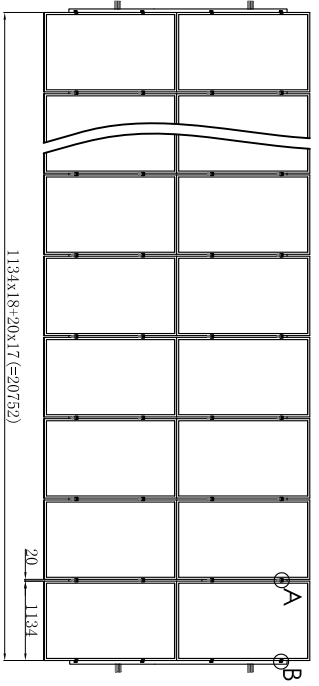

VIEW A

VIEW B

VIEW C

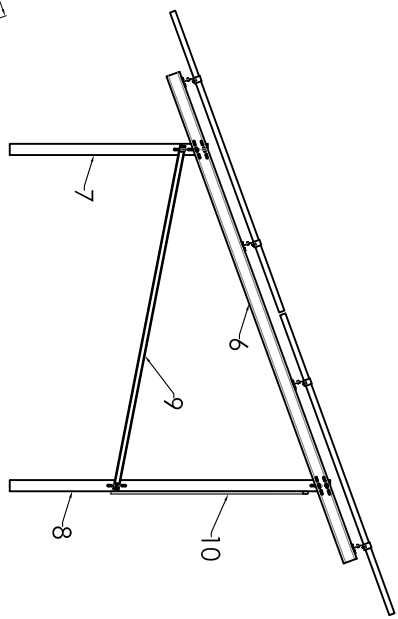
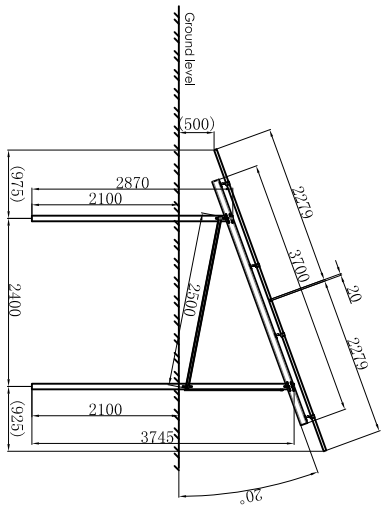
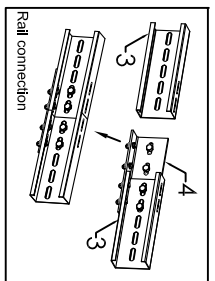
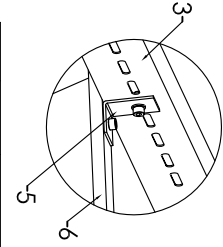
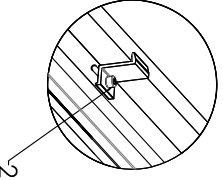
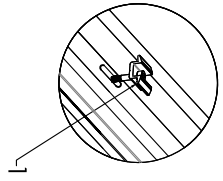

Installation Site	Unless other specified, the main dimension unit is mm	
Wind Load	30m/s	Drawn by/Date
Snow Load	1.0 KN/m ²	Checked/Date
Angle	20°	QA./Date
Panel	2279*1134*35	Standard/Date

VER.	DCN NO.	Project information	Approved/Date
Change Mark		Change History	

No.	Part NO.	Item	Description	QTY	U/N
11	CP-AM12-30	M12x30 Screw, Flat washer, Spring washer, Nut		62	SUS304
10	CP-C4220-3160	C type Steel siltflener, C 40°20'2.0	L=3160	7	Aluminium Zinc Magnesium Zinc
9	CP-C4220-2500	C type Steel siltflener, C 40°20'2.0	L=2500	8	Aluminium Zinc Magnesium Zinc
8	CP-C8420-3745	C type Steel Leg, C 80°40'2.0	L=3745	8	Aluminium Zinc Magnesium Zinc
7	CP-C8420-2870	C type Steel Leg, C 80°40'2.0	L=2870	8	Aluminium Zinc Magnesium Zinc
6	CP-C10520-3700	C type Steel Beam, C 100°50'2.0	L=3700	8	Aluminium Zinc Magnesium Zinc
5	CP-RSGM-C	Rail Clamp		32	Q235
4	CP-RS-C	Rail Connection		12	Q235
3	CP-C8420-5220	C type Steel Rail, C 80°40'2.0	L=5220	16	Aluminium Zinc Magnesium Zinc
2	CP-EC-35	End Clamp		8	AL6005-T5
1	CP-IC-35	Mid Clamp		68	AL6005-T5

CORIGY 科锐欧(厦门)新能源科技有限公司
 Create Re-Energy
 xiamen corigy new energy technology CO.,LTD.
 TEL: 0592-6883200 E-mail: sales@corigy.com

Model Layout	2x18	Drawing NO.	CP-02161001-01
Project	CP-SP Single pole solution Ground Solar Project	DATE	2022-12-02